Installation Guide

V2.31 May 2014

AIW2X / AIW4X

Invisible Loudspeakers



Caution: Read before installing this product

- To ensure optimal performance, please read this guide carefully and keep in a safe place for future reference.
- Install this product in a cool, dry, clean place - away from direct sunlight and heat sources, strong vibrational forces, chemical fumes, dust and moisture (steam).
- Do not expose this product to sudden temperature changes or locate it in an environment with high humidity. This is to prevent condensation forming inside which may cause damage to the product.
- Do not clean this product with chemical solvents as this may damage the finish. Use a clean, dry or damp cloth.
- Ensure that all installation mounting surfaces are able to support the weight of the product.
- After installation, avoid pushing on the wall or ceiling surface immediately in front of the speaker. Excessive excursion, whilst unlikely to damage the speaker, will undoubtedly crack the plaster around its perimeter.
- Do not attempt to modify or repair the product. Contact your distributor or manufacturer if a fault should occur.
- The rear of the product should not be subject to chemical cleaning and should not be painted in any way.
- When plastering over, ensure only 2mm of material covers the product. More than this will degrade the performance of the product and could lead to product failure.



ENVIRONMENTAL:

Before installing, ensure that the building is environmentally sealed, de-humidified and at a stable temperature of at least 16 degrees centigrade (61 degrees Fahrenheit)

This product should not be used with single thick coat plaster solutions or with other finishing methods that take days (rather than hours) to dry out.

Please be aware that when this product is directly fitted into a solid wall structure (e.g. when using the solid wall backbox) vibrational energy is inevitably transferred into the solid wall structure. This energy can travel for some considerable distance up, down and along the structure. It is therefore recommended the product be fitted within acoustically insulated stud walls or ceiling sections where possible. The use of the product directly embedded in solid walls is not recommended in multi occupancy buildings.

Equally, using the product in simple (stud or rafter with plasterboard or floor board directly attached on both sides) stud walls & wooden rafter ceiling/floor structures will also transfer substantial sound energy to the other side of the wall or floor above. It is therefore recommended that the product be fitted in acoustically isolated stud walls or ceiling sections where possible.



WARNING:

No attempt should be made to install this product within existing building structures unless you are certain that no electric cables, water pipes, gas pipes or supporting joists will be cut through.



FIRE PROTECTION:

When making an intrusion into an internal wall or ceiling to install an Amina loudspeaker be sure to check the appropriate regulations pertaining to the required fire rating. Depending on the location of the intrusion and the applicable regulations it may be necessary to build in or install additional fire rated components or products to surround the speaker and back box. Amina Technologies take no responsibility for the correct specification and installation of any such fire protection system that is required behind their speakers.

Contents

- 01 Message from the Managing Director
- 02 Included in the carton / Packaging
- 03 How to use this manual
- 04 Installation overview diagram

Section **A**

Preparing the wall / ceiling and fixing the product

- 05 Cavity Installation steps 1 + 2
- 06 Cavity Installation steps 3+4
- 07 Cavity Installation steps 5 + 6
- 08 Cavity Installation with backbox steps 1 + 2
- 09 Cavity Installation with backbox steps 3
- 10 Solid Wall Installation with backbox steps 1 + 2
- 11 Solid Wall Installation with backbox steps 3+4
- 12 Solid Wall Installation with backbox step 5

Section **B**

Alignment and plastering preparation

- 13 Retrofit (patch plastered)
- 14 Retrofit (feathered skim)
- 15 Retrofit (full wet skim)
- 16 Drywall (patch plastered)
- 17 Drywall (feathered skim)

Section **C**

Testing

- 18 Testing the speakers

Section **D**

Finishing

- 19 Plastering and decorating steps 1 + 2
 - 20 Plastering and decorating steps 3 + 4
 - 21 Setup tips
 - 22 Setup tips
 - 23 Further details
 - 24 Troubleshooting
 - 25 Specifications / Evolution Series & APU
 - 26 Spacesaver information
 - 27 Warranty & copyright information
 - 28 Accessories
 - 29 Contact information
-

Message from the Managing Director

Congratulations and thank you for purchasing an Amina Technologies AIWX Series high performance invisible loudspeaker.

At Amina we are proud of being at the forefront of flat panel loudspeaker technology. All the components that make up your AIWX Series loudspeaker have been developed specifically to provide the ultimate in sound quality and reliability, whilst allowing you to decorate, furnish 'and enjoy your home in any way you wish without any visible 'clutter' from your audio system.

At the heart of an AIWX Series loudspeaker is our high performance vibrational panel driver, featuring a unique high power neodymium magnet motor system. This enables the product to provide high quality, high sound pressure levels from such a compact design. Please take a moment to read this guide which will help you achieve the best possible performance from your product.

Thank you and enjoy listening.

Richard Newlove
MD - Amina Technologies Ltd

About the Manufacturer

Amina Technologies Ltd is the world's leading designer and manufacturer of truly invisible loudspeaker solutions. Our invisible loudspeakers have been used in a wide range of both commercial and residential applications for over twelve years.

Exclusive hotels & spas, fashion retail outlets and stunning private residences have all benefited from using Amina invisible loudspeakers. Amina has created the very best discrete audio solution for architects, interior designers and all design conscious clients.

See our website for more details about Amina and a selection of prestigious projects completed using our products.



Included in the carton

Please check that your carton contains the correct number of items.

Model Number	Single
AIW2X	1x AIW2X Loudspeaker / 1x AIW4X Loudspeaker 1x APU2 4x plastic fixing blocks, 1x Spacesaver
AIW4X	
AIW2X	1x AIW2X Loudspeaker / 1x AIW4X Loudspeaker 4x plastic fixing blocks, 1x Spacesaver
AIW4X	

Packaging



CAUTION:

Take care when removing the speakers from the carton.

The packaging for the AIWX Series loudspeaker has been carefully designed to protect the product during transit. Please retain it in the unlikely event you need to return the product to your dealer or to Amina. Please recycle the packaging should you wish to dispose of it.

The outer carton is made up of 80% recycled single wall board.

Fixing options (ordered separately)

01 Basic fixing block kit

(used in cavity walls and ceilings, when BackboxCV345 cannot be used.)

02 BackboxCV345

(used in cavity walls and ceilings to reduce airborne sound generation from the rear of the speaker.)

03 BackboxFH

(60 minute fire rated hood, which also reduces airborne sound generation from the rear of the speaker.)

04 BackboxSW345

(steel backbox to build into solid walls prior to installation of speaker.)

05 Shims

(Various thicknesses available to align speaker with the front of non-standard plasterboard structures.)

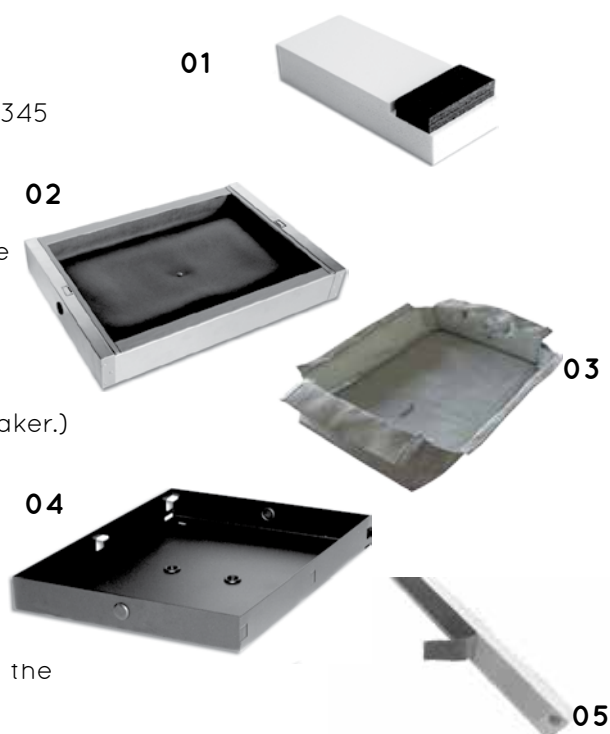

How to use this manual

The following pages contain step by step advice to help you achieve a successful installation of your ALWX Series loudspeaker(s).

ALWX Series loudspeakers can be installed into walls or ceilings of various construction types. This installation guide covers the two basic building construction types; plasterboard cavity walls/ceilings and brick/concrete walls/ceilings. For other construction types please contact Amina.

Cavity wall or ceiling

There are two options here for the installer. Either the supplied, basic fixing blocks can be used to mount the speaker to the plasterboard/drywall or an optional backbox (BackboxCV) can be used. If you are using the basic fixing blocks there will be no containment of the speaker's rearward sound output. This may or may not be an issue, however the potential for sound transfer into unwanted areas should be considered very carefully.

If the speaker's rearward sound output needs to be reduced due to sound transference considerations, it is highly recommended to use a BackboxCV. This will substantially reduce, although not stop entirely, the rearward sound output from the speaker. It also has the added benefit of providing a standardised enclosure volume for the speaker to operate in, which will reduce variances in sonic performance.

Solid wall or ceiling

For installation into brickwork or concrete you will need to pre-install an Amina BackboxSW (sold separately). When the BackboxSW is installed according to this guide it will position the speaker correctly and securely in the wall/ceiling, ready to be plastered over.

The details below and the flow chart on the opposite page will allow you to select the correct installation steps to follow for your particular type of installation.

Section **A**: Preparing the wall / ceiling and fixing the product

In this section, select the type of installation you will be carrying out and begin from the start page given. This will direct you through the stages, step by step. Throughout the step by step process, reminders will advise you to view specific pages within [Section B](#).

At this point you will need to ascertain the specific page that best matches your installation requirement within this section (e.g., is it a retrofit installation or a new build?).

Section **B**: Alignment and plastering preparation

[Section B](#) is the reference section which is to be used in conjunction with [Section A](#). Please ensure the correct alignment and plastering method for a retrofit installation or a new build is followed. Reminders on each page throughout [Section A](#) will guide the installer to the correct reference page.

Section **C**: Testing

This section advises you on the correct procedures for speaker testing, both before and after plastering.

Section **D**: Finishing

This section covers plastering and decorating once your speaker has been installed and aligned

Installation overview

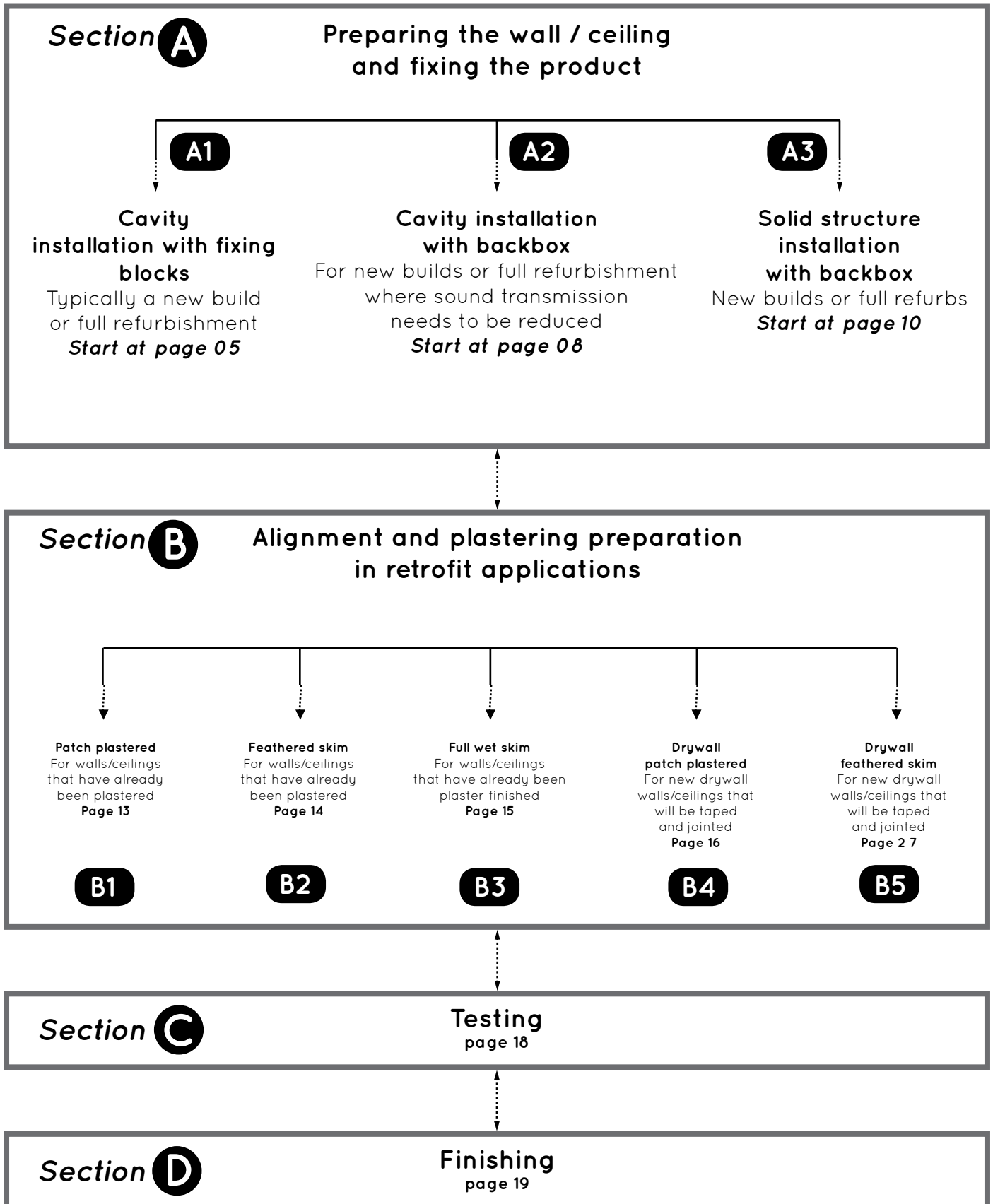

Cavity installation

Typically a new build or full refurbishment /
Uses mounting blocks (sold separately)

01 Locate joist work

When you have chosen your speaker locations, before cutting a hole in the plasterboard it is important that you locate the position of the joists/studs. Ensure the spacing between them is at least 350mm (13³/₄") for a portrait orientated speaker.

Important: If the space in between joists is less than 350mm (13³/₄"), consider using the AIW350E/S200 loudspeaker which only requires a 200mm (7⁷/₈") wide cavity.

Cut-out Template

The supplied template may be useful in marking the cut lines

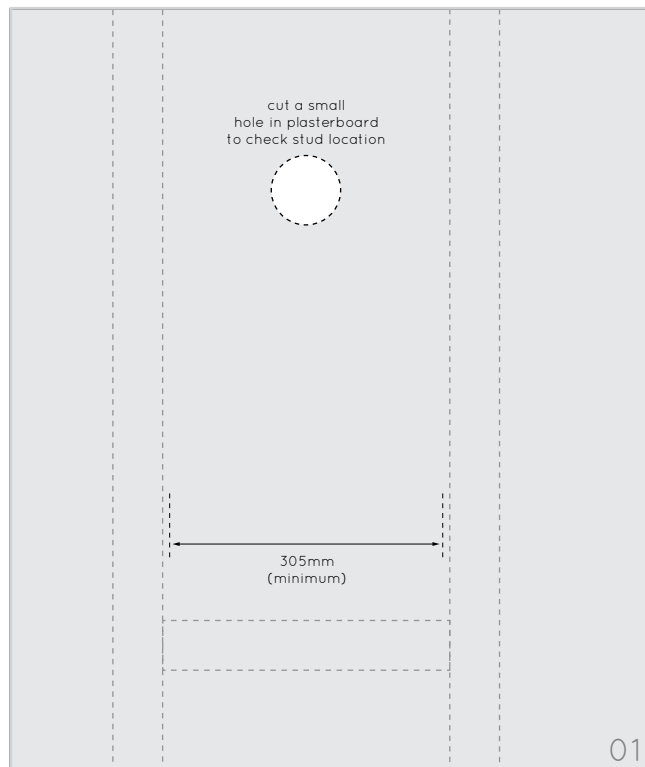

02 Create 455mm x 350mm aperture (455mmx205mm for S-200 Variants)

Using a sharp knife or pad saw, cut an aperture with dimensions 455mm x 350mm (18" x 13³/₄") in your plasterboard wall or ceiling.

Ensure aperture is created between supporting joists or stud work.

We strongly advise that joists are not cut to make space for the product. Any activity of this sort may well influence the structural integrity of your property.

Important: Double check the size of the aperture is 455mm x 350mm (18" x 13³/₄) as this is important further on into the installation process.

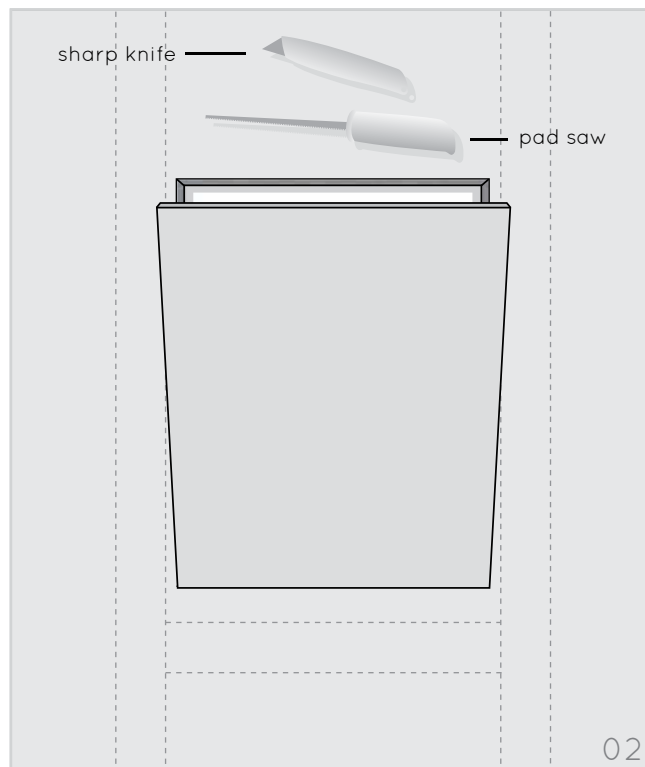

Cavity installation with fixing blocks continued...

03 Install speaker cable and insert insulation

Ensure all speaker cables are pulled through to the speaker location with plenty of slack. This will make it easier to connect the cable to the speaker later on in the installation process.

It is recommended to add sound absorbing mineral wool inside the cavity to reduce sound transmission behind the speaker and limit cavity resonances. This is essential in ceiling locations where the mineral wool will also prevent debris falling onto the rear of the speaker over time.

The mineral wool can rest against the back of the speaker but not so much as to put pressure on the panel.

Ensure the speaker cable is laid behind the mineral wool and can not rest against the rear of the panel.

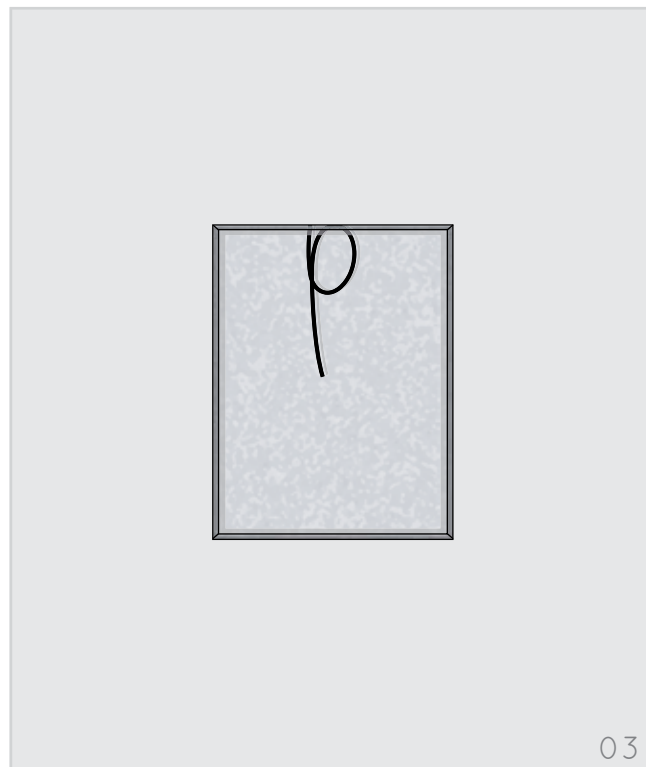

04 Attach mounting blocks (x4 per speaker)

Position a fixing block under the plasterboard at each corner of the aperture. Fasten the thicker section of the fixing blocks to the underside of the plasterboard using two drywall screws secured through the front face of the plasterboard.

NB: ensure there is no gap between the fixing block and the sawn edge of the plasterboard aperture.

Important: The fixing blocks are designed for 12.5mm (1/2") plasterboard (1/2" and 5/8" in North American markets). Please contact your supplier if you require fixings for an alternative plasterboard thickness.

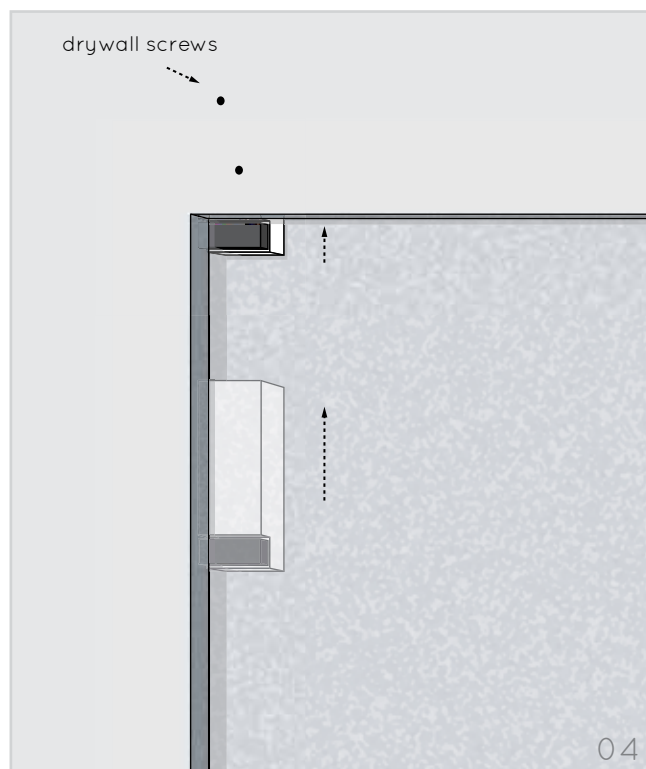

Cavity installation continued...

05 Connect the Evolution Series speaker

Connect the speaker cable to the speaker using a high quality crimping tool.

Your Evolution Series speaker is fitted with blue butt splice crimp connectors which are suitable for speaker cable thicknesses of 1.5mm^2 - 2.6mm^2 (16 - 14AWG). This type of connector ensures a permanent "shake-proof" connection is created inside your wall cavity.

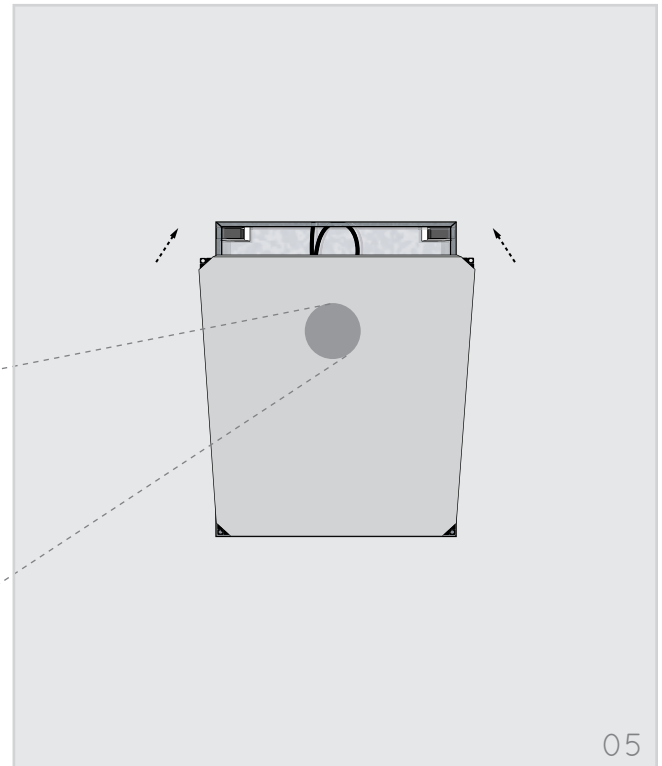
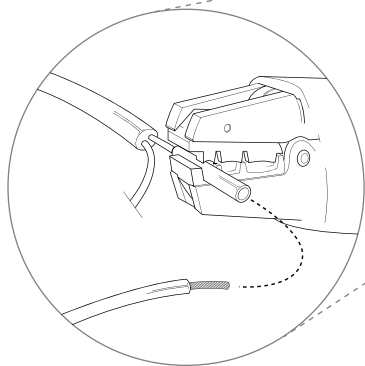

05

06 Secure the speaker to the fixing blocks

Important: Ensure there is an all round gap of 2mm between the speaker and the plasterboard. If necessary, increase the aperture size before mounting the speaker.

Using drywall screws, fix the four corner points of the speaker to the fixing blocks. Pilot holes are not necessary as drywall screws will easily self-tap into the fixing block.

Ensure the front face of the speaker rests in a position flush with the front of the plasterboard and that it is firmly held in position.

Continue on to Section C (page 18 - testing)

screw through here

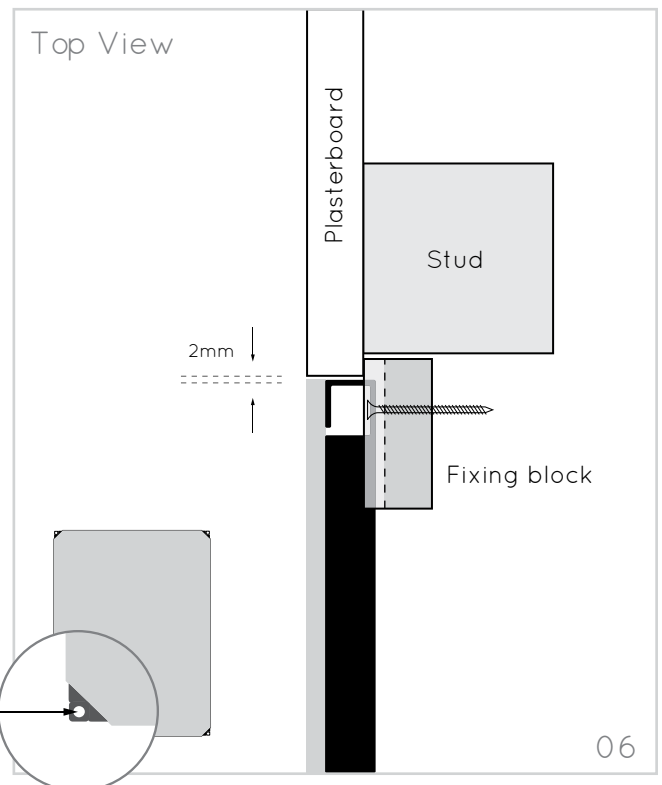

06



Reference pages for correct **retrofit** alignment and plastering method: **13, 14 + 15**
Reference pages for correct **drywall** alignment and plastering method: **16 + 17**

Cavity installation with backbox

For new builds or full refurbishment where sound transmission needs to be reduced or fire rating is required.

01 Locate cable and position backbox

Choose speaker location and create aperture by following steps 01 + 02 on page 05. Use the cut-out template as a guide.

Next, pull the speaker cable through the rubber grommet in the top side of the backbox and ensure speaker cables are pulled through with a manageable length available.

Apply the Backbox through the hole at an angle until the end cheeks rest against the back side of the plasterboard.

Use the fold out tabs at either end of the backbox to help support it in a vertical position before securing it to the plasterboard.

A 75mm/3" cavity depth is required to fit a BackboxCV or Firehood.

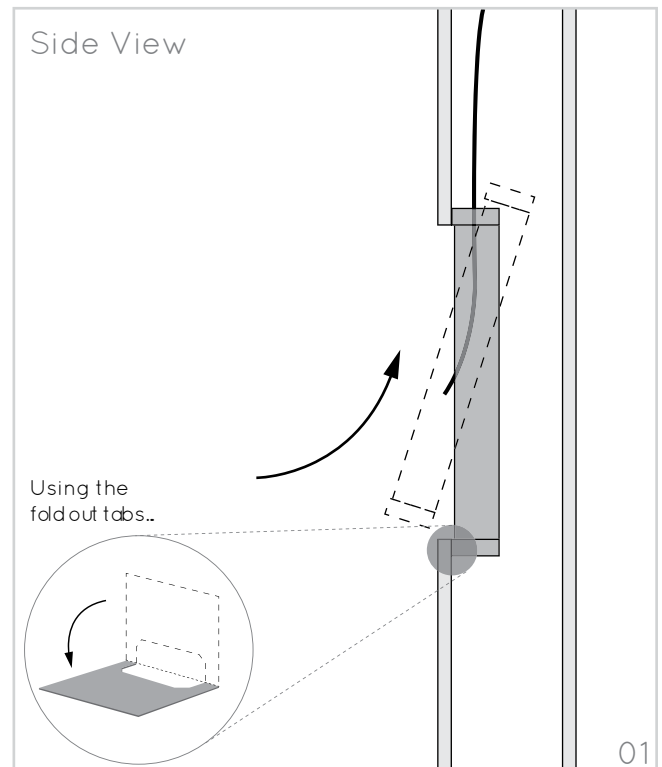

02 Fix backbox

Using a minimum of 8 drywall screws (4 at each end) fix the backbox by screwing through the plasterboard and self tapping into the flat end cheek areas at each end of the backbox. When positioned correctly, the backbox's speaker mounting lip with soft foam surface should be visible along all four sides of the aperture.

Connect the speaker by following step 05 on page 07.

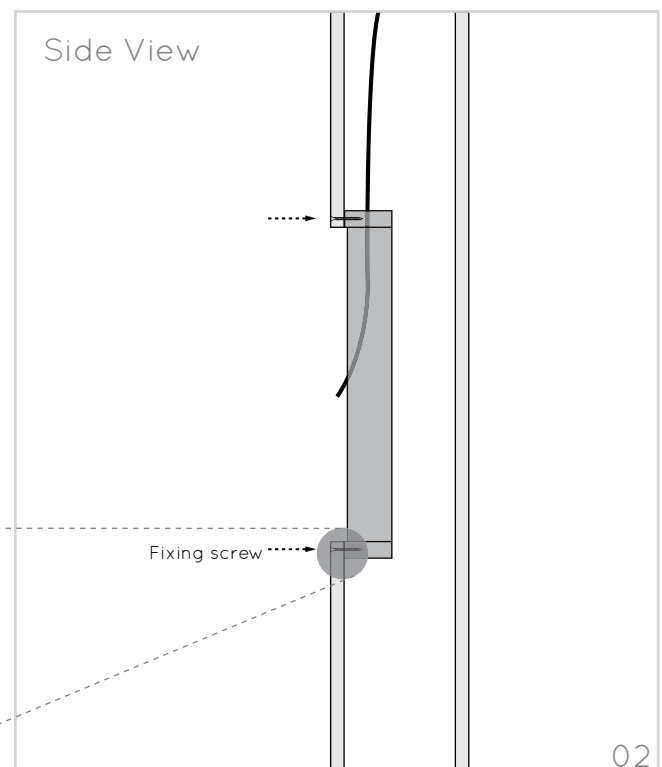
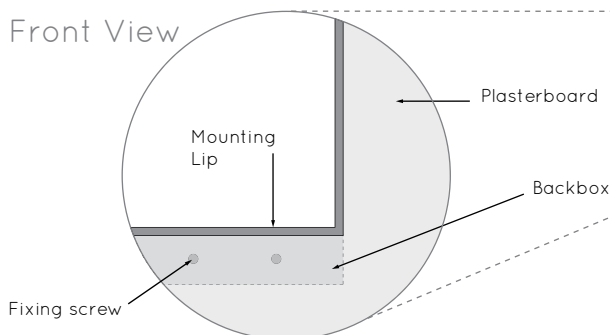

05 Connect the speaker

Follow step 05 on page 07

Secure the speaker

Position the cable away from the rear of the loudspeaker. With the speaker resting on the backbox mounting lip, use screws provided to secure the speaker onto the backbox by self-tapping into the mounting lip, through the pilot holes provided at each corner.

Ensure the speaker face is flush with the front of the plasterboard and that everything is firmly held in position. Shims may be necessary. (See section B)

Amina backboxes (Backbox CV and Firehood) are designed for 12.5mm (1/2") plasterboard.

Shims can be supplied to adapt the backbox for different plasterboard thicknesses. Contact your supplier when ordering.

**Continue on to Section C
(page 18 - testing)**

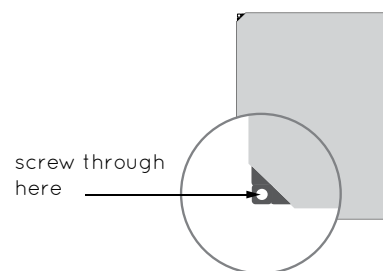
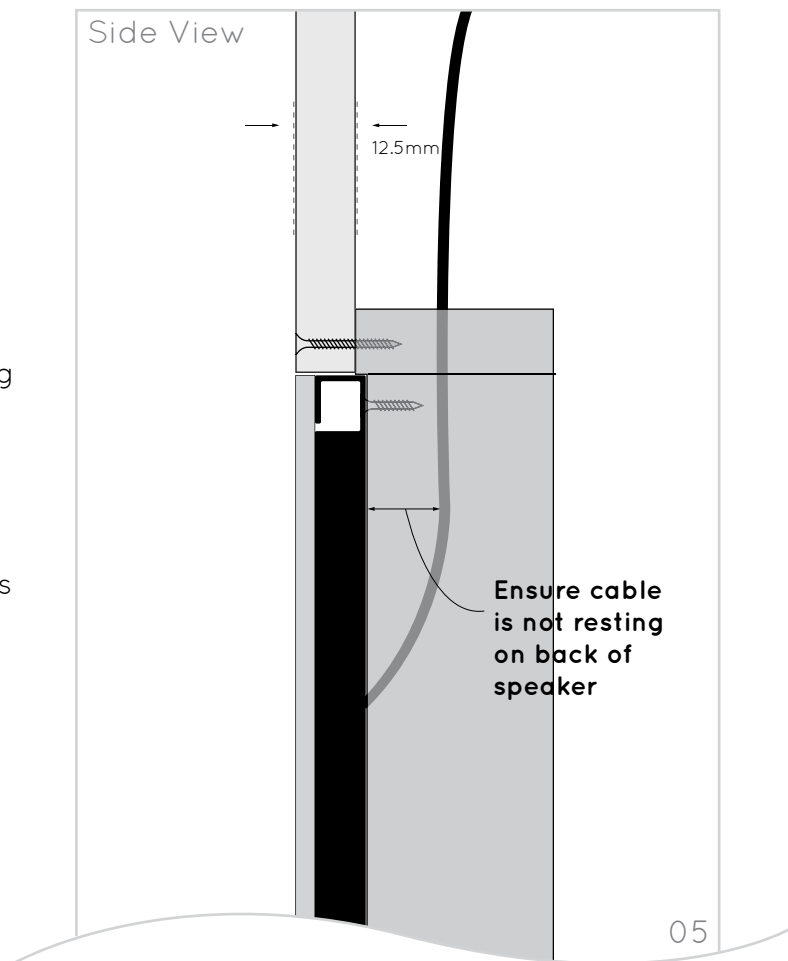

Reference pages for correct **retrofit** alignment and plastering method: **13, 14 + 15**
Reference pages for correct **drywall** alignment and plastering method: **16 + 17**

Solid wall installation with BackboxSW

A3

10

For new builds or full refurb

01 Create aperture in brickwork/ concrete

Using the combination of an angle grinder and a jackhammer drill, create a cavity of 460mm x 355mm (18½" x 14") within the brickwork. (460mm x 210mm for S-200 variants)

Before installing the backbox you will need to know the thickness of render that will be applied to the wall/ceiling prior to the finish plaster skim.

Minus that thickness from 50mm (2") to calculate the minimum cavity depth you will need to create.

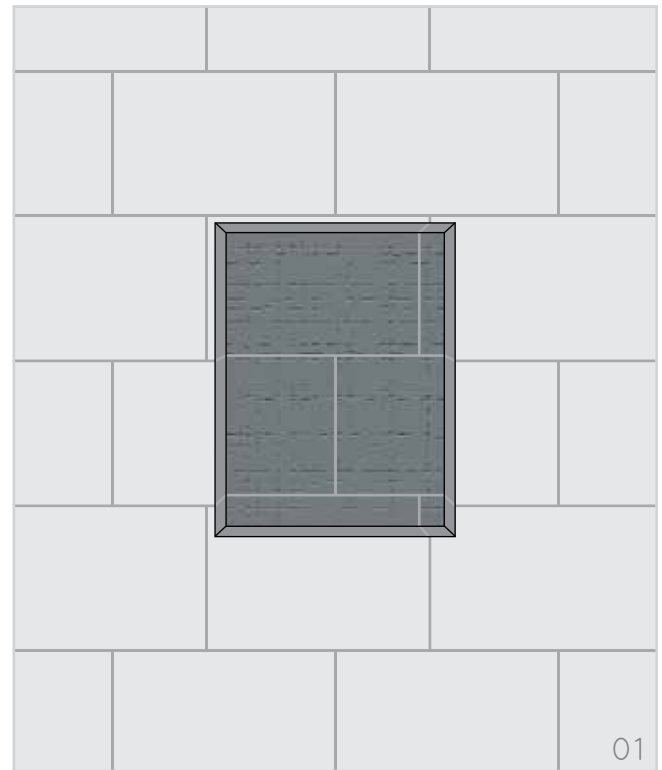

02 Create channel for cable

Using an angle grinder or hammer and chisel, create a channel that runs into this cavity, this will allow the speaker cable to be pulled into a suitable position within the cavity.

We recommend the cable is run in a suitable conduit to protect it.

Leave enough cable slack to allow connection to the speaker when it is held away from the cavity.

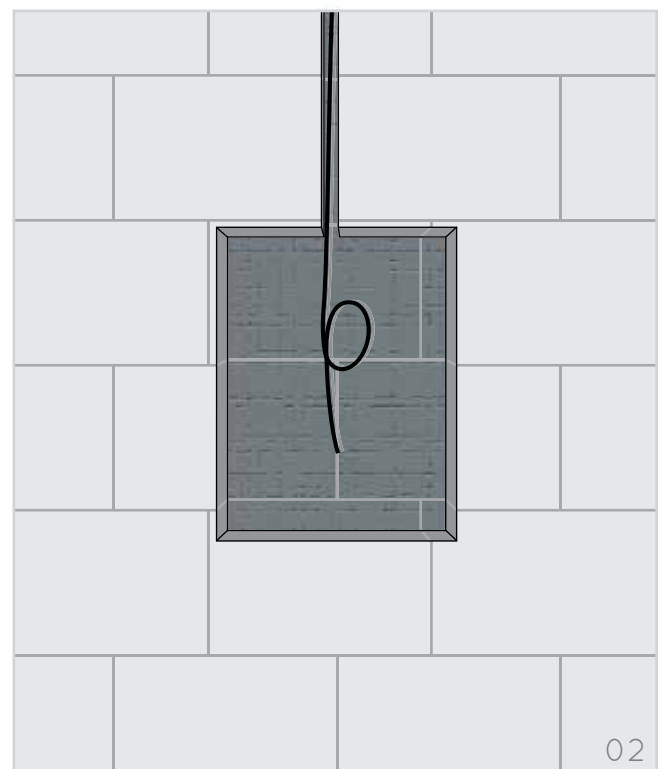

Solid wall installation with backbox continued...

03 Install backbox

Make a small hole in one of the rubber grommets and pull the speaker cable through it and into the backboxSW. There are four slots in the base of the backboxSW and using suitable screws (not supplied), fix the backboxSW to the brickwork within the cavity. Ensure the front edge of the backboxSW aligns flush with the front face of the surface which will have the final 2mm skim coat of plaster applied.

We recommend shims are fitted behind the backboxSW to achieve a level solid fixing. It is recommended to add expanding foam around the sides and rear to prevent resonance and also to add mineral wool (max 1") to the inside of the BackboxSW.

NB: If there is a layer of render to be applied or already applied to the brickwork, be sure to align the front edge of the backboxSW to the front edge of the render (As shown in the lower section of the image)

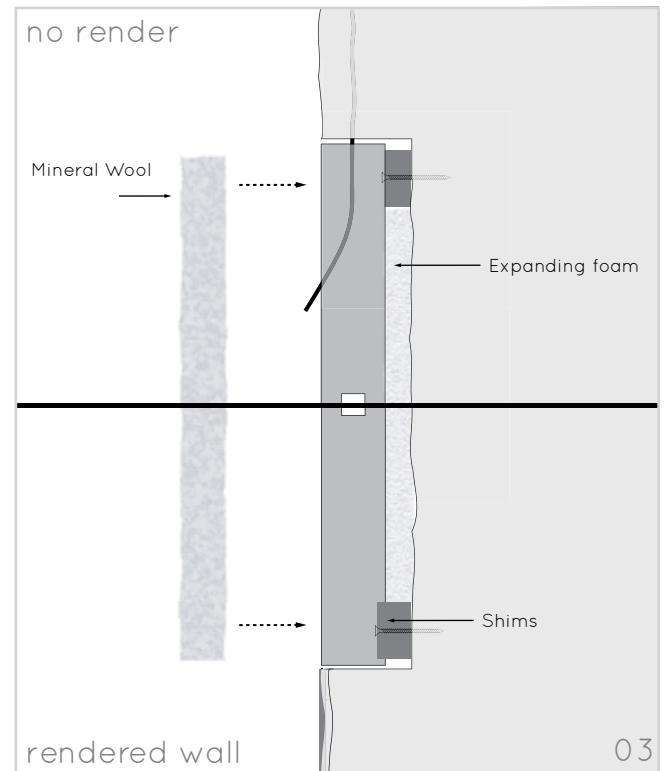

04 Connect speaker

Connect the speaker cable to the speaker using a high quality crimping tool.

Your Evolution Series speaker is fitted with blue butt splice crimp connectors which are suitable for speaker cable thicknesses of 1.5mm^2 - 2.5mm^2 (16 - 14AWG). This type of connector ensures a permanent "shake-proof" connection is created inside your wall cavity.

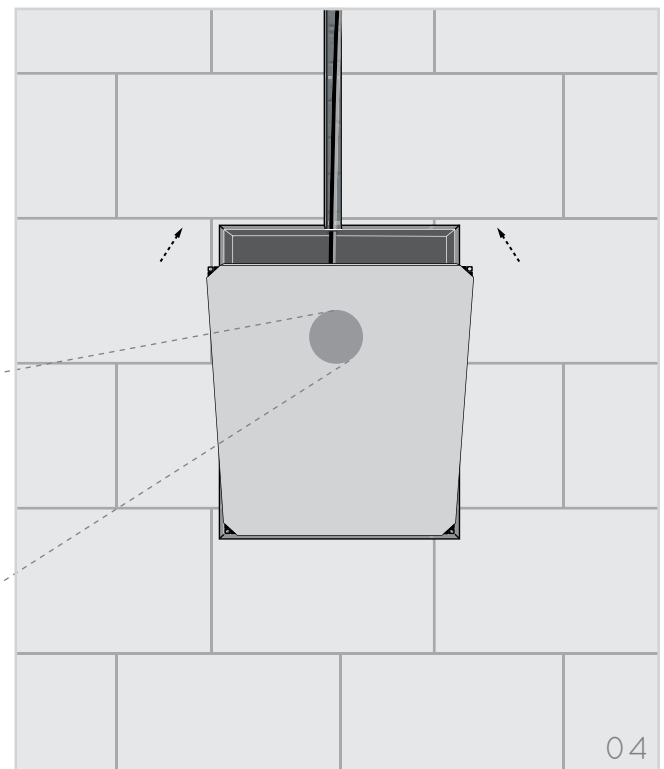
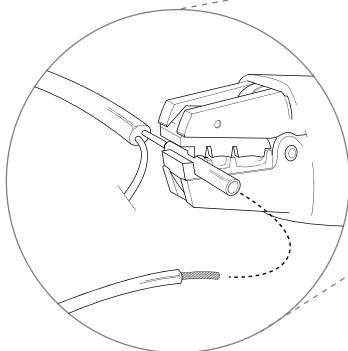

Solid wall installation with Backbox continued...

05 Secure the speaker

Ensure the speaker cable is laid behind the mineral wool and cannot rest against the speaker itself.

Remove the backing paper from the six adhesive pads on the backboxSW mounting tabs, carefully position the speaker onto the support tabs and apply moderate pressure.

There should be an equal perimeter gap between the backbox and the edge of the speaker.

Use the flange head screws (supplied with the backboxSW) to fix the corners of the speaker to the four corner support tabs.

If the correct steps are taken to align the backboxSW with the front face of the render, the loudspeaker, when screwed in place, will also sit flush with the front face of the render.

Do not adjust the screws in any way, make sure they are tightly screwed in place and the whole assembly is firm.

**Continue on to Section C
(page 18 - testing)**

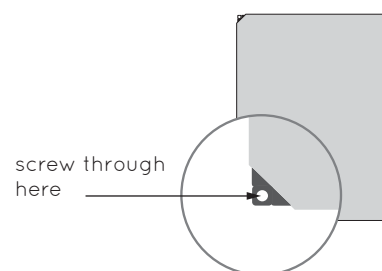
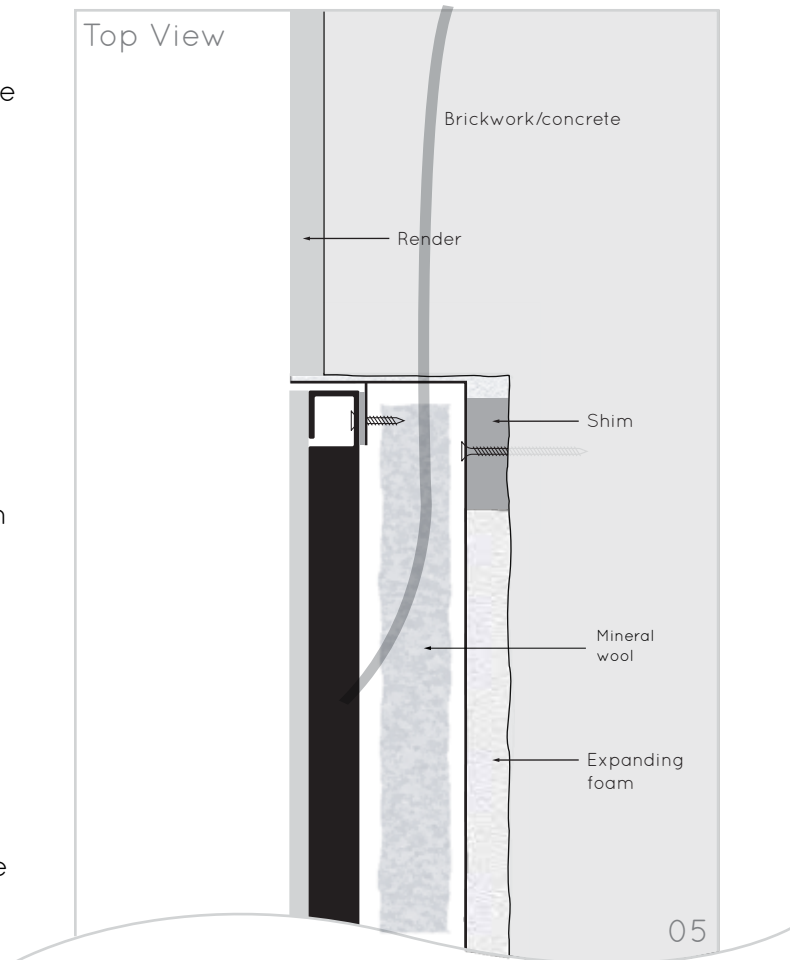

Reference page for correct **retrofit** alignment and plastering method: **13, 14 + 15**

Retrofit / pre-skimmed plasterboard

B1

Patch plastered finish

For walls / ceilings that have already been plaster finished.

Speaker alignment required for plastering

After removing a 30-50mm (approx 2") wide section of existing plaster surrounding the cut out, the front face of the speaker should be flush with the paper face of the plasterboard.

To patch plaster:

Skim across the speaker front and blend with the existing finished plaster.

Amina recommend British Gypsum Easi-fill® which allows a smooth accurate finish using fine sandpaper or a wet sponge.

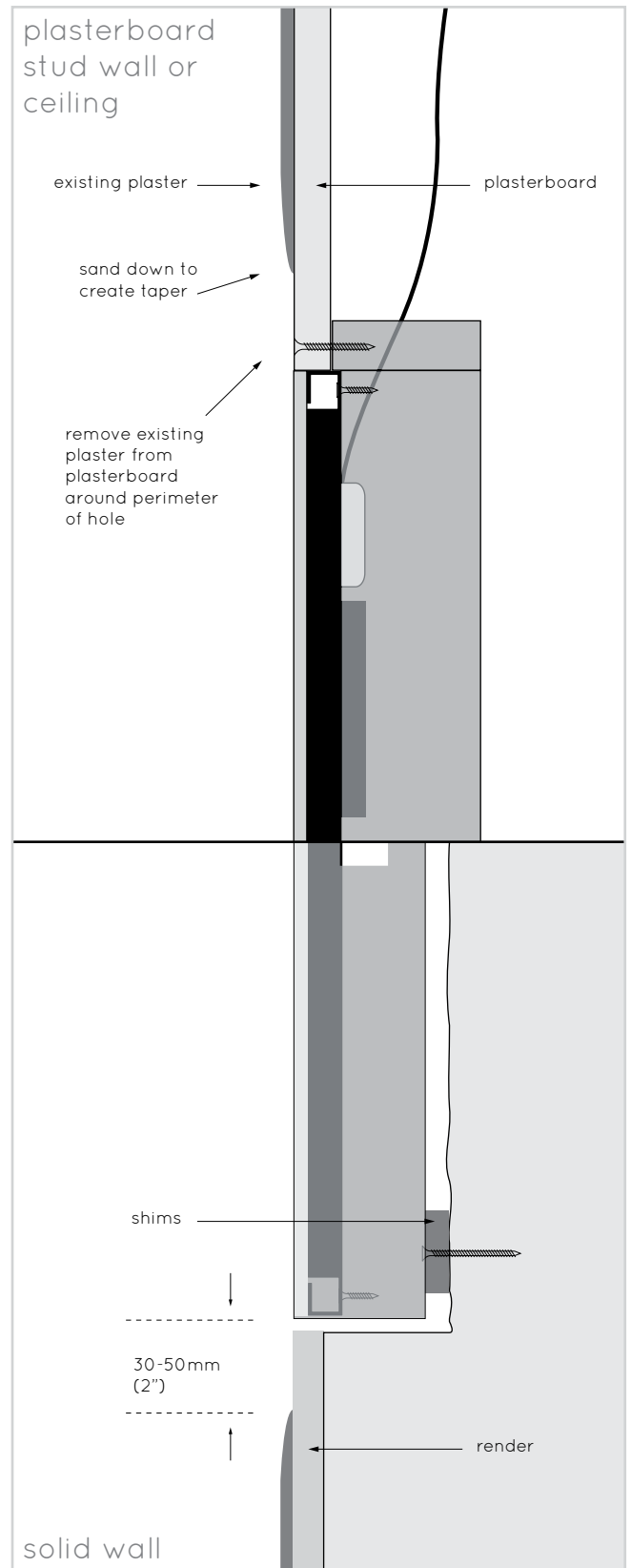
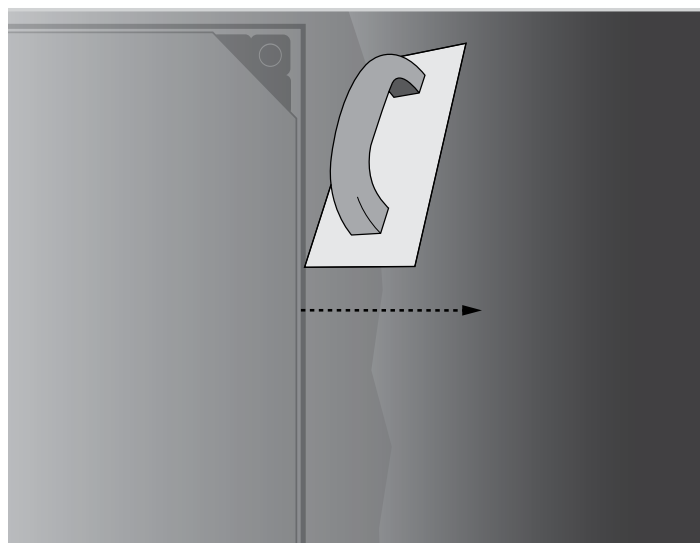

Continue to section



Retrofit / pre-skimmed plasterboard

B2

Feathered skim finish

For walls / ceilings that have already been plaster finished.

Speaker alignment required for plastering

Using a 2-3mm shim set (contact your Amina supplier) between the back of the speaker and the mounting surface of the backbox (or fixing blocks), the front face of the speaker should be flush with the front face of the existing painted/plastered wall/ceiling

To feather finish:

Allow a much larger area around the speaker (approx. 1m² (39")) to be skimmed. This 1-2mm (5/64") thick skim is then feathered outward at the edges and blended into the existing wall/ceiling finish.

Amina recommend British Gypsum Easi-fill®.

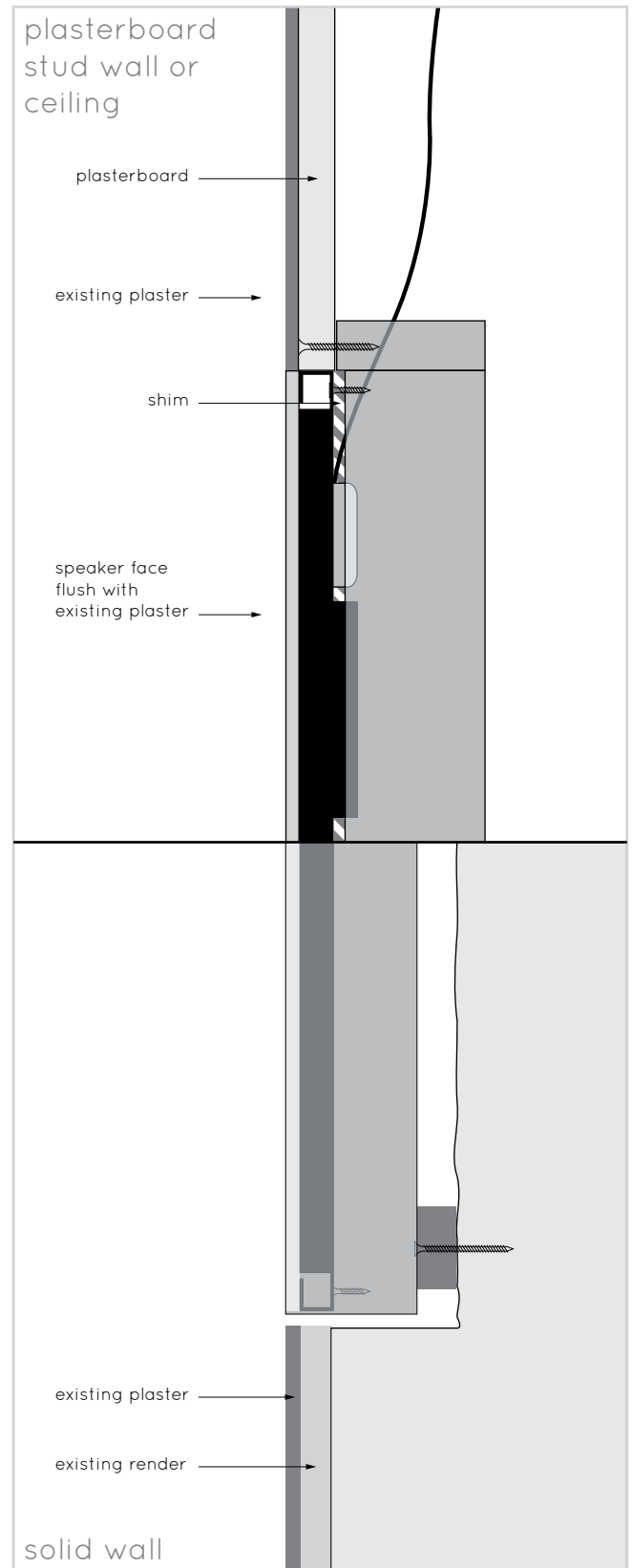

Continue to section



Retrofit / pre-skimmed surfaces

Full wet skim finish

For walls / ceilings that have already been plaster finished.

Speaker alignment required for plastering

Using a 2-3mm shim set (contact your Amina supplier) applied between the back of the speaker and the mounting surface of the backbox (or fixing blocks), the front face of the speaker should be flush with the front face of the existing painted/plastered wall/ceiling.

To full wet skim finish:

The speaker will be skim coated along with the rest of the wall or ceiling.

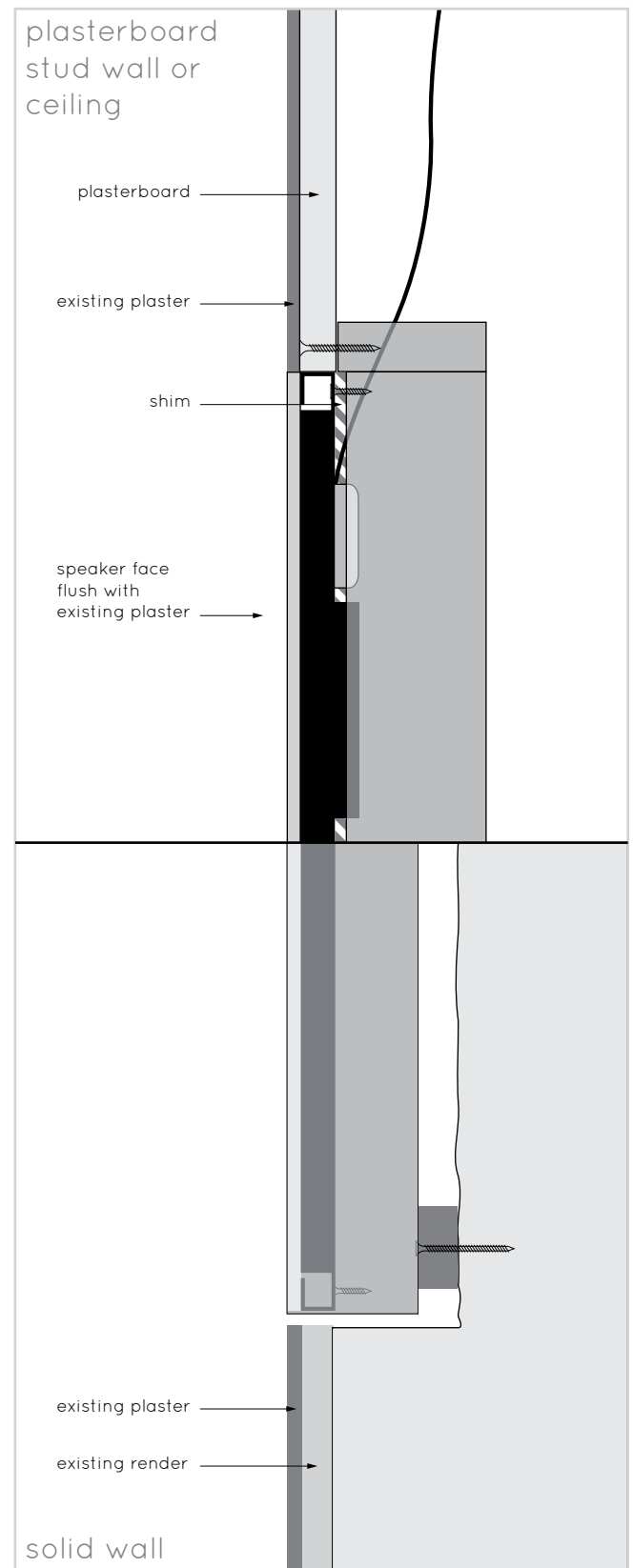

Continue to section



Retrofit drywall

Patch plastered finish

For new drywall walls / ceilings that will be taped and jointed.

(typically in North America but becoming common elsewhere)

Speaker alignment required for plastering

Using shims if required, the front face of the speaker should be located 2mm (5/64") behind the face of the wall/ceiling.

To patch plaster:

Apply a 2mm skim across the speaker front and blend with the drywall.

Amina recommend British Gypsum Easi-fill® which allows a smooth accurate finish using fine sandpaper or a wet sponge.

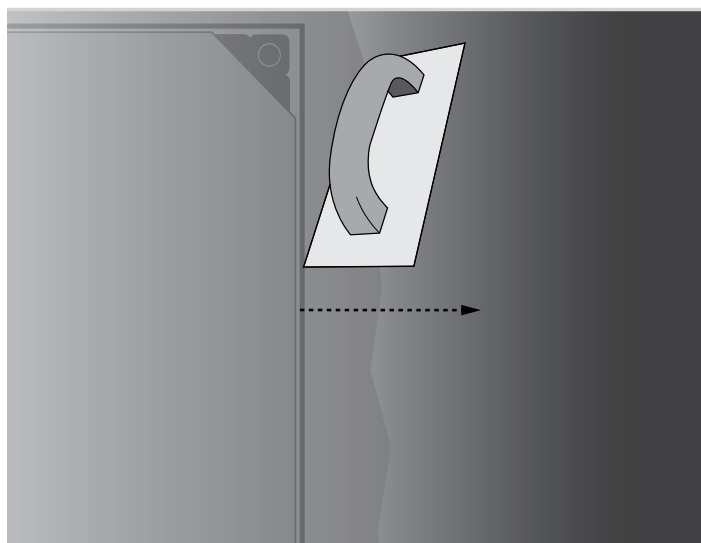
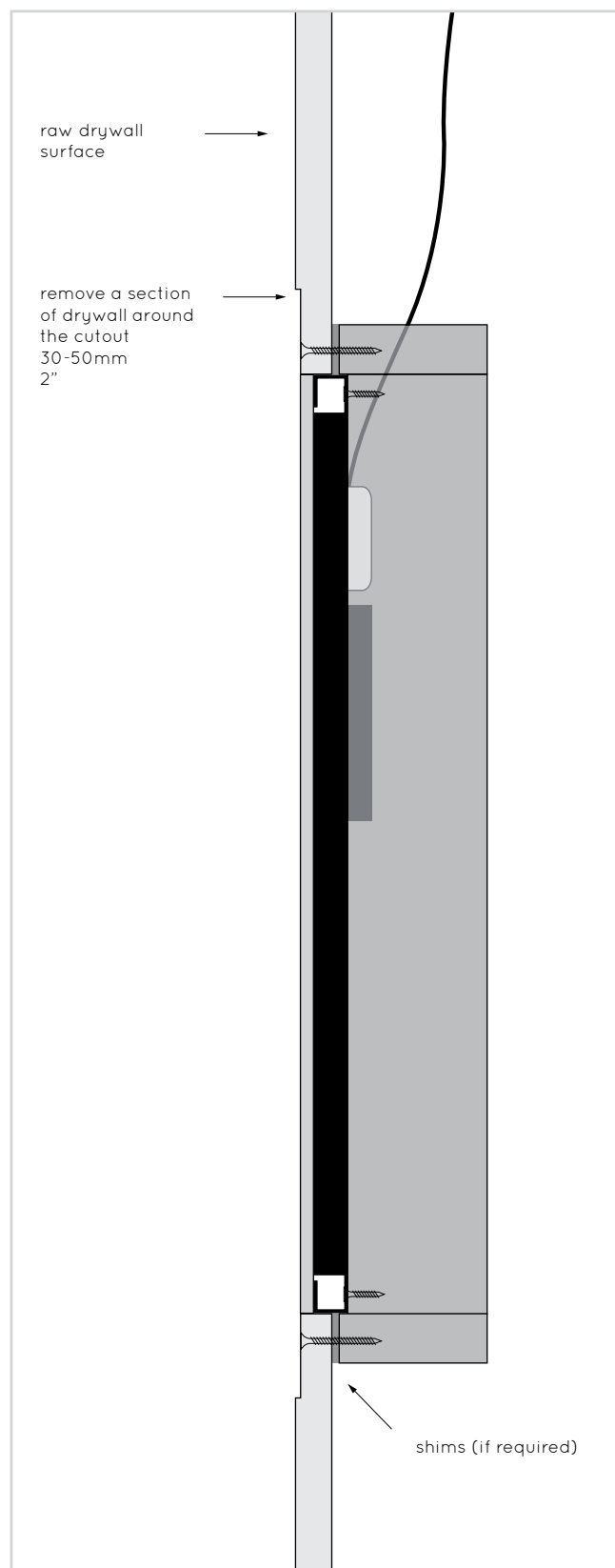

Continue to section



Retrofit drywall

Feathered skim finish

For new drywall walls / ceilings that will be taped and jointed.

(typically in North American but becoming common elsewhere)

Speaker alignment required for plastering

The front face of the speaker should be flush with the face of the new wall/ceiling if correctly installed.

To feather finish:

Allow a much larger area around the speaker (approx. 1m² (39") to be skimmed. This 1-2mm (5/64") thick skim is then feathered outward at the edges and blended into the drywall.

Amina recommend British Gypsum Easi-fill®.

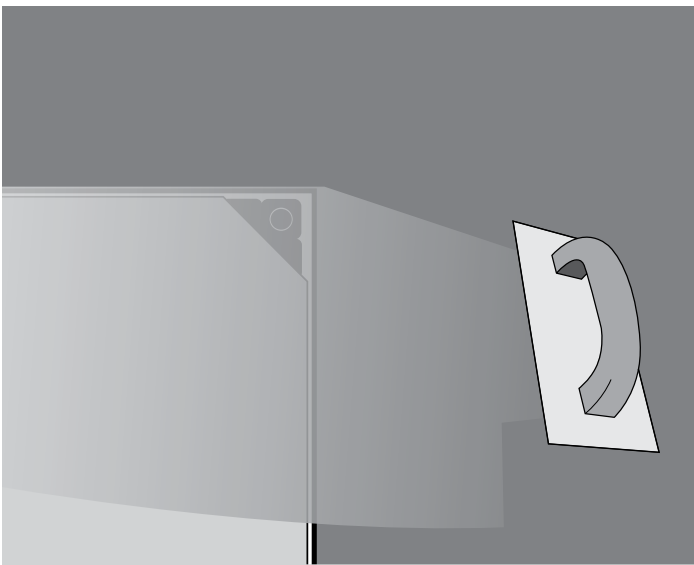
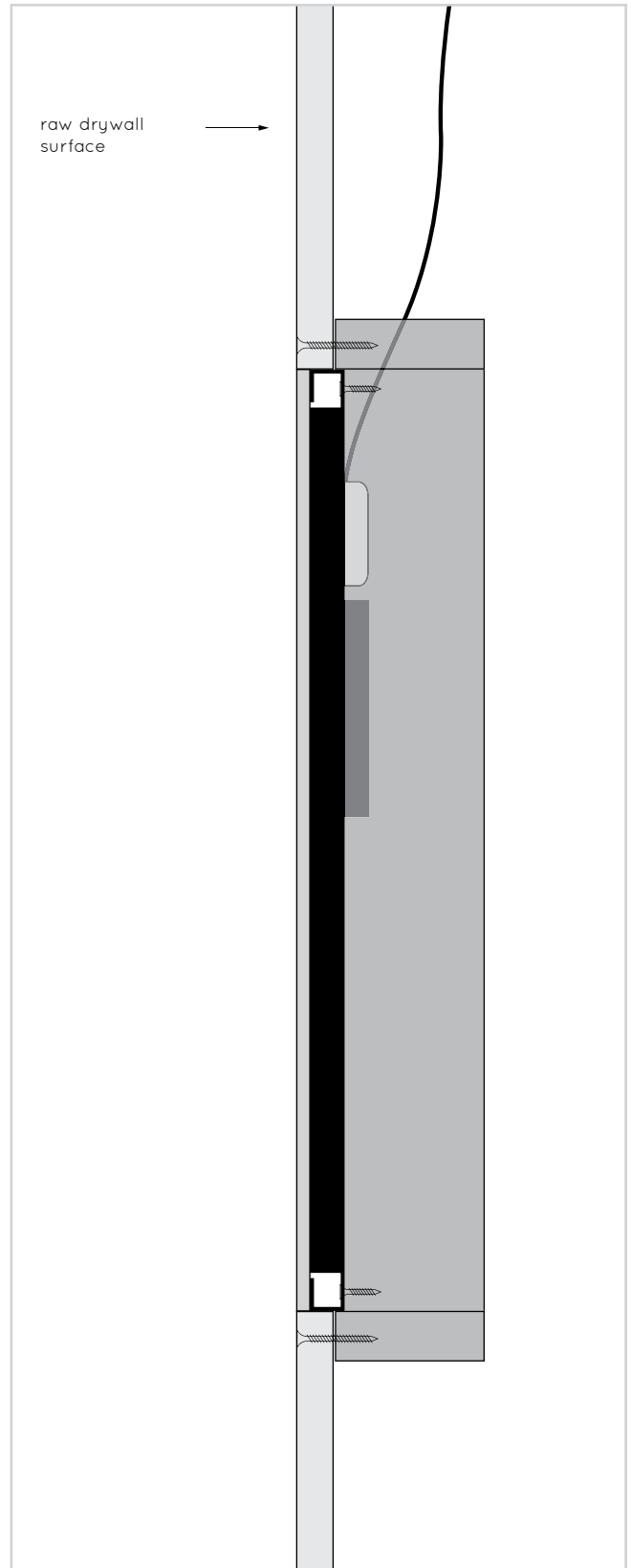

Continue to section



Testing the speakers



Important: Always test the speaker before plastering over it and again once plaster is dry.

The following procedure is required as a minimum.



CAUTION:

Without plaster on the surface of the speaker it is highly efficient and will generate very high sound pressure levels with minimal power input. Take care to protect your ears when testing at this stage.

- Using a multimeter and without the APU protection device connected, check the nominal impedance (DC resistance) of the speaker at the amplifier end of the speaker cable. Allow for approx. +10% for cable resistance. The impedance should coincide with the values on the respective loudspeaker datasheets. If it measures significantly different, check for breaks or shorts in the cable.
- Amina recommends a tone sweep be used at a moderate volume level (0.5 Vrms). Such a test will quickly highlight any buzzes or rattles that could be caused by loose screws, cables touching the speaker or loose elements/studs within the wall itself.
- If the plasterboard is not securely fastened to the joists this could also create a buzz or a rattle. Apply more screws if necessary - particularly around the speaker location.
- Ensure that the speaker cable is not touching any part of the speaker (or backbox) as this can lead to buzzes and rattles. To avoid this it is advised to lay the cable behind the mineral wool or other wadding.
- If metal studs are used, ensure the crossover point of the studs are secured together. This can be achieved by applying drywall screws through the wall surface and through the metal joists. If they are not secure this may well lead to audible vibrations and rattles.
- Play music to check for buzzes and rattles during transient peaks: if these are apparent, check the above points again. Do not judge the speaker's tonal balance at this stage. The overall speaker performance must be clean and distortion free, although at this stage it will appear biased toward mid and high frequencies. Once plastered over the speaker will have a fuller, richer sound.
- Always connect the APU when testing, except when measuring impedance.
- Perform these tests again after the plaster is dry.
- If the correct 2mm thick plaster coat has been applied, the speaker face, when tapped with fingers, will sound slightly more hollow than the surrounding areas of plasterboard. If there is little or no difference between these two sounds it is almost certain the plaster coat is too thick. This will compromise the speaker performance.

Full frequency response tests are recommended before and after plastering

*Amina have a lot more information available from its technical help desk for those wishing to measure frequency response curves at different stages of the installation.
Please contact +44 (0)1480 354390 for assistance.*

Continue on to Section D (page 18 - plastering & decorating)

Plastering and decorating



01 Fill gap between speaker and surrounding area

It is important to ensure that plaster is pushed into the 2mm (5/64") gap that surrounds the speaker. This will create a strong bond between the edge of the speaker and the edge of the wall.

Use a low shrinkage repair plaster such as British Gypson Easi-fill®

This further helps to prevent any cracks appearing in the skim finish.

IMPORTANT: There MUST be a gap of 2mm (5/64") all the way around the speaker edge. If there isn't simply remove the speaker and increase the aperture size accordingly (plasterboard installations only)

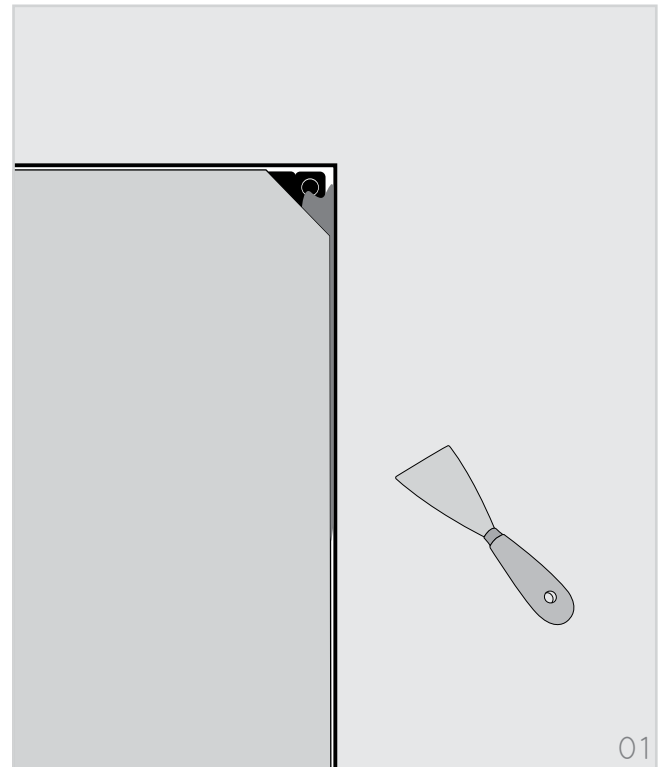

02 Apply joint tape

Apply the self-adhesive fibreglass joint tape (supplied by Amina or your distributor) to the speaker face. Ensure it covers the entire speaker face and the plasterboard joints

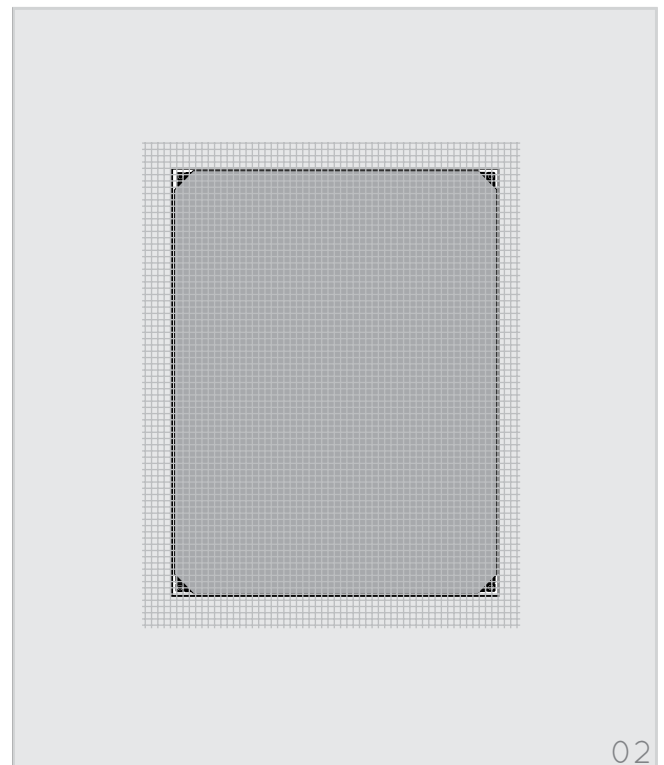

03 Plastering

Use standard finishing plaster for large areas. For patch plastering use a low shrinkage repair plaster such as British Gypsum Easi-fill®

Please refer to the appropriate page in Section B (alignment and plastering preparation for your specific installation type). Pages 13 - 17

Important: To ensure proper operation and sonic performance, no more than 2mm (5/64") of plaster must be applied to the surface of the panel.

For non-standard plater types please contact Amina or your distributor

04 Decorating

Allow your plasterwork to dry completely. Test the speaker again (see Section C, page 18). You can then paint the surface or hang wallpaper in the usual manner.

Amina invisible speakers have been optimised for three coats of emulsion once plastered. Additional coats will cause very small reductions in the maximum sound pressure levels achievable.

Note:

Amina have separate guides for information about installing the product behind other materials and surfaces such as wooden panels, acrylic and melamine laminates.

Contact Amina if you require any additional information (page 29)

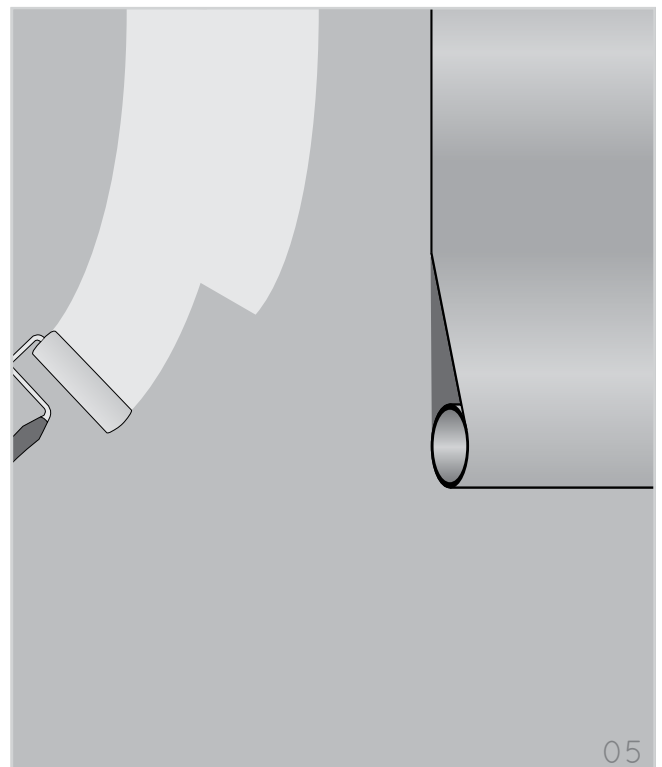

Setup tips

> **APU2 / APU-RS8**

Your AIWX speaker must be used with the supplied APU protection device. AIWXn models should be used with an APU2 or APU-RS8 or Amina approved active device in commercial systems. Please refer to the detailed instructions supplied with the APU2 and APU-RS8 for connection advice.

> **AIWX Audio Characteristics**

Your AIWX speaker generates sound in a similar way to an acoustic musical instrument. The speaker's front face is effectively the "musical" soundboard and the sound waves generated from it are diffuse and are dispersed over a very wide angle. This characteristic has the benefit of allowing positioning to be far less critical than with conventional speakers. Additionally, just like the acoustic musical instrument, the AIWX has excellent room filling abilities.

> **Wall or Ceiling Placement**

The AIWX is suitable for both wall and ceiling installations. When the most uniform audio coverage in a room is required it is best to space the speakers evenly in the ceiling. However if the room has a height greater than 6m (19') Amina suggests installing the speakers in the walls at a height of around 1.8m (6').

> In dedicated listening rooms where AIWX speakers are used in stereo or multi channel systems, position in walls so that the centre point of the AIWX is approximately 1 – 1.8m (3 - 6') from the floor, this will give excellent results. Don't worry if this is not possible to achieve as the audio characteristics of the AIWX makes exact positioning according to stereo/5.1/7.1 conventions far less critical.

> **Speaker Orientation**

Amina have designed the AIWX to be installed either in portrait or landscape orientations and there is no audible benefit in positioning them in one orientation over the other.

> **System Requirements**

From a system compatibility point of view your AIWX can be treated like any conventional 8 Ohm speaker. Amina recommend you use a good quality amplifier so as to avoid driving them with a distorted signal which may permanently damage the speaker. Amina also recommend you connect the AIWX to your amplifier with at least 16AWG OFC cable (14AWG for long runs) to avoid any chance of reduced efficiency and audio bandwidth. For 2.1/5.1 and 7.1 systems, always set the amplifier to divert frequencies below 120Hz to the subwoofer. This will improve the overall sound quality and power handling of the system. (APU2 and APU-RS8 should still be used).

> AIWX speakers are sonically revealing and will highlight any shortcomings in the source or amplifier.

> **Sound Transmission**

As with any speaker designed to be fixed to a structure within a wall or ceiling, careful consideration should be given to sound transmission into adjacent rooms or properties. We recommend specialist advice is taken if sound transmission into adjacent rooms needs to be minimised. See the Amina specifiers guide for information on reducing sound transmission as a starting point.

> **100/70V Option**

For multi-speaker commercial and industrial installations, AIWXn speakers can be supplied with 100/70V line transformers fitted.

Speaker selection guide

Amina Technologies AIWX Loudspeakers are compatible with all standard audio amplifiers, they are passive and come supplied with an inline protection device (APU2)

There are two models in the AIWX range and referring to the table below will allow you to select the appropriate model(s) for your particular project.

	Room Size											
	<9 m ²				9 - 25 m ²				>25 m ²			
	Background Music	Foreground Music / HiFi	Home Cinema	PA	Background Music	Foreground Music / HiFi	Home Cinema	PA	Background Music	Foreground Music / HiFi	Home Cinema	PA
AIW1X	●				●				●			
AIW2X	●				●				●			
AIW3X	●	●	●		●	●			●			
AIW4X	●	●			●	●			●	●		
AIW5X		●	●	●		●	●	●		●	●	●

AIW2X and AIW4X are dual-channel speakers. They feature 2 input connectors for connecting a 2-channel feed (i.e stereo) and output this as mono. They are useful in situations where only one speaker is required, for example in small rooms.

Note 01: For home cinema applications, a powerful active subwoofer is recommended.

Note 02: For main listening rooms, greater warmth is achieved through the addition of some bass enhancement such as can be provided by an Amina ALF40 subwoofer

Further details

Maintenance and cleaning

Once your AIWX speaker is plastered into your wall or ceiling, it requires no physical maintenance. Your wall or ceiling can be cleaned with products appropriate to the finish finally applied to the plaster surface.

The wall or ceiling can be painted or redecorated any number of times (see proviso, page 24, step 5). Extreme care should be taken when removing wallpaper type coverings to ensure the plaster surface is not damaged. If damage to the plaster work occurs, use repair plaster to restore the plaster surface prior to re-decorating. Amina Technologies Ltd recommends British Gypsum Easi-fill® repair plaster. Avoid pushing the wall or ceiling surface immediately in front of the speaker. Excessive excursion, whilst unlikely to damage the speaker, will undoubtedly cause the plaster to crack around its perimeter.

Reliability

Correctly installed and used within its specification, the Amina AIWX series speaker is designed to give many years of trouble-free service. The vibrational soundboard technique used by the AIWX has very few moving parts. Compared to a conventional moving coil speaker these movements are insignificant. Whilst the human touch can feel the tiny movements, they cannot be seen by the naked eye. Such small movement of this electromechanical structure means the long term reliability is enhanced compared to much larger movements of conventional loudspeakers.

Removal

In the unlikely event of a problem developing with the product, or you simply wish to remove the item to change its location, please refer to the following guidelines:

Locate the speaker by tapping the wall or ceiling listening for a hollow sound compared to the rest of the wall/ceiling. Then, with a sharp chisel or decorator's scraper, carefully chip into the plaster to expose a small area of the panel surface. To ensure you do not damage the panel, hold the tool at an acute angle to the wall or ceiling. Now, holding the scraper almost parallel to the panel surface, work outwards towards the product's edge easing the plaster away from the panel. Do not worry if the panel surface receives marks or indented scratches during this process (it should not, however, have holes entering through to the unique honeycomb panel). Once the product is plastered back into its original or new location, the new skim of plaster will cover all these imperfections and the speakers performance will not be unduly affected.

Clear the surface plaster material from the surrounding plasterboard to expose all the joint tape and subsequently remove it. Use a narrow chisel or flat blade screwdriver to remove the plaster and expose the screws at each corner of the product. Using a suitable screwdriver, remove the four screws and then ease the product from the wall or ceiling and disconnect the speaker cable. Leave all four fixing blocks in place as these can be used to support a small section of plasterboard when making good the wall/ceiling.

If the product needs repairing, please return it to your supplier or Amina Technologies Ltd. Once repaired, the product can be refixed into position following appropriate installation steps detailed earlier within the manual.

Troubleshooting

Thorough testing of the speakers should be carried out both prior to and after plastering to avoid time consuming repairs or modifications at a later stage. Should you encounter any problems at either of the test stages the following guide is designed to help determine possible problem areas.

> **Advice for testing:**

- When testing always use a basic sound system (amp, source, speakers) to eliminate the possibility of faults with other, more sophisticated components, such as control systems.
- Test at low and medium volumes and be careful not to exceed the specific speaker model's recommended power. Using tone sweeps or music as test material, listen for distortion, buzzing or rattles at appropriate levels. Using test discs or music, confirm that all channels are in-phase.
- Ideally professional test equipment should be used to record a full frequency response of the loudspeaker before and after plastering.

> **No or low sound output:**

- Check continuity of all cables.
- Check that all cables and connections are made correctly, are intact and that all channels are correctly phased (+ to + and - to - from amp to speaker).
- Using an impedance meter, check the nominal impedance of the speaker (APU must not be connected) both at the terminals and the amp end of the cable. Do these measurements match each other? (Allowing for the small impedance increase of less than 1 ohm along the wire length) do they match the stated nominal impedance on the speakers specification label? If the nominal impedance does not match the product's stated impedance, a speaker driver may be open circuited or short circuited. If so, the product may need to be returned to Amina for repair or replacement.
- If the nominal impedance at the end of the cable is very different to the impedance at the speaker, check your cables. Cuts or nicks in the cable along its length can dramatically increase impedance or create a short circuit, dramatically lowering the impedance.

> **Distortion, buzzing or rattles at modest volumes:**

- Try to identify the location of the buzz or rattle. It may be caused by a loose screw or other mechanical object. Check the wall or ceiling and speaker assembly and ensure screws and fixings are tight.
- If the rattle persists, remove the speaker from the wall and check your wiring to the product. Ensure that wires, with the speaker in the final location, are not resting against the speaker or backbox (if used), causing vibrations.
- With no audio signal applied, lightly push the speaker face in and out at its centre. Listen carefully for rubbing on the driver, which may sound like scratching. This may indicate the speaker has been over driven and subsequently damaged. The speaker will need to be sent to Amina for repair or replacement.

> **Very low output after speaker passes electrical tests:**

- With no audio signal applied, lightly push the panel in and out at its center. Listen carefully for rubbing voice coils on the driver, which may sound like scratching. This may indicate the speaker has been over driven and subsequently damaged. The speaker will need to be sent to Amina for repair.

> **Distortion at higher volume levels:**

- Diffuse source panel loudspeakers of this type have an extremely fast response, articulating the signal from your audio system very accurately. Take your system back to the bare minimum (amplifier, source and speakers) to eliminate distortions introduced by other components.
- When using your amplifier at maximum power levels, or if the input of your amplifier is being overloaded, the signal level may be 'clipping'. With some conventional speakers this may not be evident, but with a diffuse source panel speaker you are much more likely to hear the distortion. Consider adjusting or upgrading your system.

Specifications

Model Number	AIW2X	AIW4X
Dimensions	450 x 345 x 38mm	
Weight	1.13kg	1.76kg
Nominal Impedance	8 Ohms	
Frequency Response	100Hz - 20kHz	
Sensitivity (2mm plaster/mud skim)	85dB @ 1m/1W	88dB @ 1m/1W
Connection	butt-splice crimp terminal	
Power Handling (continuous/peak)	20W + 20W	40W + 40W
Manufacturer warranty	10 years residential	

Specifications: APU2

Model Number	APU2
Dimensions	190 x 100 x 42mm (7 1/2 x 4 x 1 5/8")
Weight	0.5Kg
Filter type	Passive 3rd order high pass. 20dB/octave slope
Fuse protection	Self-resetting, current sensing type.
Compatibility	AIW2X AIW4X
Number of channels	2
Connection type	1x Springcon® 4 pole connector per channel.
Maintenance requirements	Protection fuses can be set by the installer if necessary.

For multi-channel speaker systems, Amina recommend the APU-RS8, an 8 channel, in-line rack mounted version of the APU2 protection unit. Please contact Amina if you would like further information on this product.

Spacesaver information

01 Using the Cut out Template for pre-install

Staple to plasterboard/ drywall to act as a template.

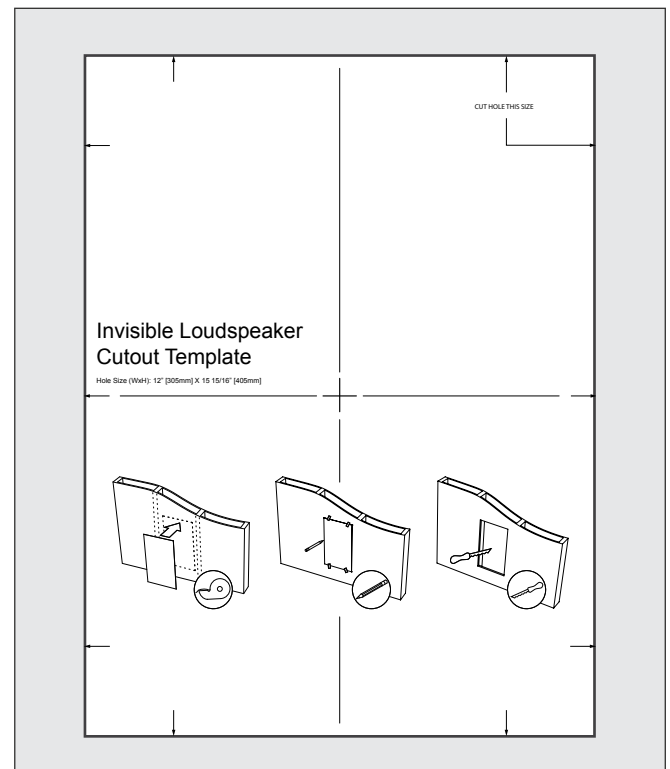

02 Using the cut out template

1. Ascertain joist position behind plasterboard/ drywall.
2. Ensure cut out dimensions fit between the joists.
3. Use a knife to cut around the outside of the template.

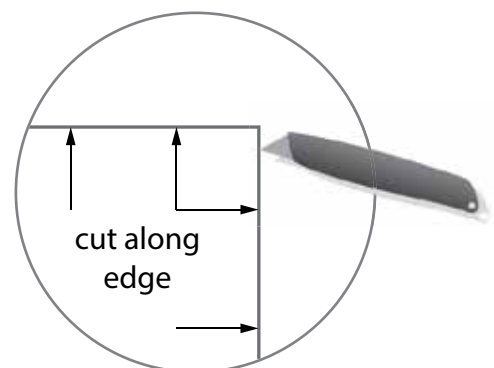

Warranty information

Limited Warranty:

The Amina AIWX Series speakers are designed to operate reliably for many years. Correctly installed in accordance with these instructions, Amina warrants the AIWX Series speakers against defective materials and workmanship for a period of five years in commercial applications and ten years in residential applications.

At the end of the speakers useful life and in compliance with the European directive on waste electrical and electronic equipment (WEEE), this product is to be returned to your supplier, or directly to Amina for recycling. If you have any questions please contact Amina Technologies Ltd.



* Please refer to our full warranty statement for details, available **on our website, or alternatively contact us via email.**

Important Note: This product does not comply to European Construction Products Directive EN 54-24 and therefore must not be used in voice evacuation systems located within the European Union.

Copyright information

This document is Copyright of Amina Technologies Ltd, 2014
Easi-fill is a registered trademark of British Gypsum Ltd
Amina is a registered trademark of Amina Technologies Ltd

Accessories

APU2 and APU-RS8E

Passive, in-line protection units for AIWX Series speakers are available in 2-channel versions and in an 8-channel, 1U rack mountable version.

AIW2X & AIW4X – APU2 (2-channel) / APU-RS8E (8-channel)

These protection devices are required to be connected between Evolution speakers and your power amplifier under Amina's warranty conditions.



ALF40

40W compact, passive bass enhancer with unique adjustable port design allowing the product to be installed within joinery, behind kick boards or within ceilings or other voids. Highly discrete, high quality bass enhancement is achieved with only a small opening for the port required within the room.

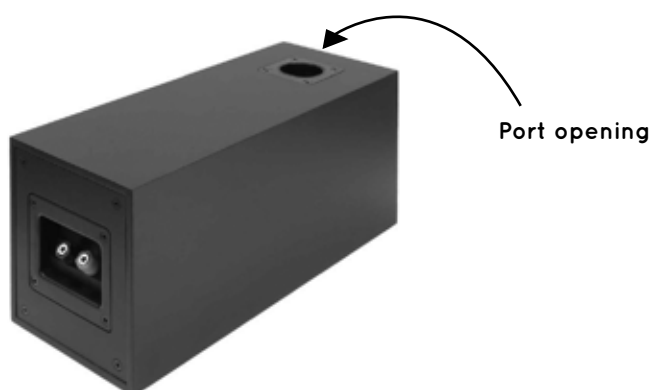

ALF80

150W passive subwoofer with unique adjustable port design allowing the product to be installed within joinery, behind kick boards or within ceilings or other voids. Highly discrete, powerful and deep bass response is achieved with only a small opening for the port required within the room.

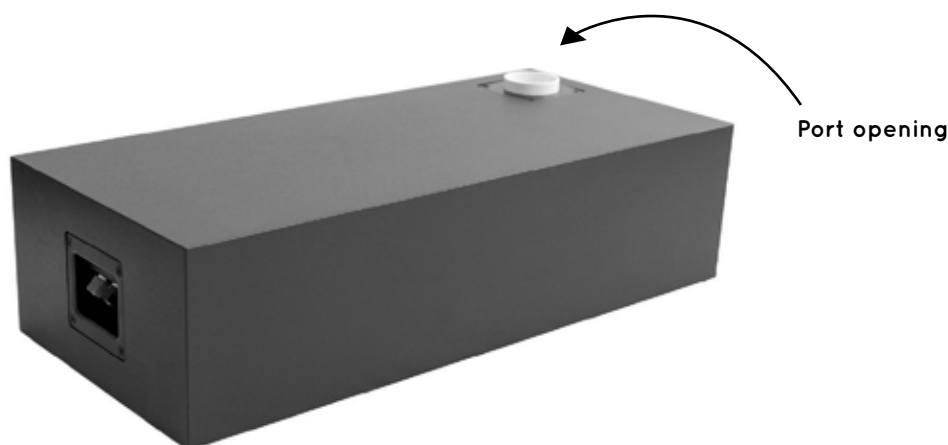



Amina Technologies Ltd

Cirrus House, Glebe Road, Huntingdon
Cambridge, PE29 7DL, UK
T: +44 (0) 1480 354390
E: inspired@amina.co.uk
W: www.amina.co.uk

North America

Direct: 1-905 655 6411
Toll free: 1-866 462 6462
Toll free Fax: 1-888 329 2491
E: salesna@amina.co.uk
